

# Alfa Laval Unique Mixproof Horizontal Tank

## Double seat valves

### Introduction

The Alfa Laval Unique Mixproof Horizontal Tank Valve is a versatile, highly flexible double block-and-bleed valve for the safe and efficient management of fluids at intersection points in matrix piped systems.

To improve the cleanliness of the horizontal tank connections. It ensures that no area of the tank inlet or tank outlet is left uncleaned, it is specifically designed for horizontal mounting on the side of a tank or as a space-saving alternative at the bottom of a cone-formed tank. Its self-cleaning design provides state-of-the-art cleanability in the shadow area, where no Cleaning-in-Place pressure or flow from the tank side to clean the connection.

Based on the proven and versatile Alfa Laval Unique Mixproof Valve, the Unique HT Mixproof Valve enables the benefits of having two different products or fluids in the same valve without any risk of cross-contamination. The valve provides greater flexibility by filling and emptying a tank at the same time.

### Application

The Alfa Laval Unique HT Mixproof Valve is designed for continuous flow management and process safety for horizontal tank inlet and outlet applications across the dairy, food, beverage and many other industries.

### Benefits

- Enhanced product safety, cleanability and operating efficiency
- Spillage-free operation with leakage detection and leakage chamber cleaning
- Easy maintenance and parts replacement
- Low total cost of ownership
- Capable of cleaning shadow areas in tank connections

### Standard design

The Alfa Laval Unique HT Mixproof Valve is comprised of a series of base components, including valve body, valve plug, actuator, seat lift and two patented Cleaning-in-Place (CIP) nozzles.

The double tangential design of the valve body ensures full drainability in any position, when mounted at the bottom of a cone-shaped tank or on the side. The design of the single valve body makes it suitable to weld directly on the tank or to

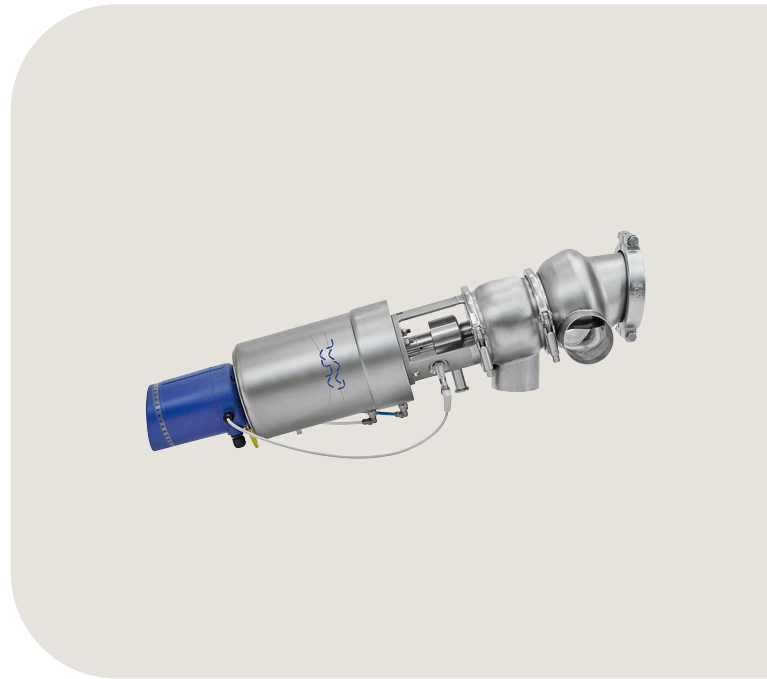

connect it using a tri-clamp. There are three sizes: 2½", 3" and 4". The 4" model features a 45-mm opening, which enables the passage of large particles or efficient handling of high viscosity fluids.

The valve is self-cleaning, thanks to two patented CIP nozzles. The first nozzle is designed specifically for plug cleaning. This double-acting nozzle projects cleaning media through the tank connection, ensuring complete cleaning of the seat contact surfaces as well as the shadow area of the tank port. The second is a rotating CIP nozzle incorporated into the unit for optimum cleaning of the full-bore leakage chamber.

Leakage detection holes enable visual inspection without requiring valve disassembly and provide advance notification of parts wear. Few straightforward moveable parts contribute to reliable operation and reduced maintenance costs.

The valve can also be fitted with the Alfa Laval ThinkTop V50 and V70 for sensing and control of the valve.

### Working principle

The Alfa Laval Unique HT Mixproof Valve is a normally closed (NC) valve controlled from a remote location by means of compressed air. The valve has two independent plugs to

separate the liquids; the space between the seals forms a leakage chamber at atmospheric pressure during every working condition. Leakage rarely occurs but, should it occur, product leaks into the leakage chamber and exits through the bottom outlet for easy detection.

When the valve is open, the leakage chamber is closed. The product then flows from one line to the other. The radial

design of the valve ensures that virtually no product spillage occurs during valve operation. It is possible to adapt valve cleaning and water hammer protection to the requirements of individual process specifications.

#### Certificates

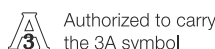

### TECHNICAL DATA

Pressure	
Max. product pressure in pipeline:	1000 kPa (10 bar)
Min. product pressure:	Full vacuum
Air pressure:	Max. 8 bar (800 kPa)

Temperature	
Temperature range:	-5°C to +125°C (depending on rubber quality)

ATEX	
Classification:	II 2 G D <sup>1</sup>

<sup>1</sup> This equipment is outside the scope of the directive 2014/34/EU and must not carry a separate CE marking according to the directive as the equipment has no own ignition source.



#### Note!

In order to use Unique Mixproof valves in ATEX environment, the blue plastic cover at lower plug must be removed for the valve types where the valve is delivered with the cover mounted.

### PHYSICAL DATA

Materials	
Product wetted steel parts:	1.4404 (316L)
Other steel parts:	1.4301 (304)
External surface finish:	Semi-bright (blasted)
Internal surface finish:	Bright (polished), Ra < 1.6 µm
Product wetted seals:	EPDM

Other seals:	
CIP seals:	EPDM
Actuator seals:	NBR
Guide strips:	PTFE

#### Valve body combination

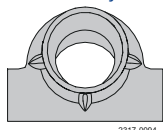

Figure 1. Welding ends

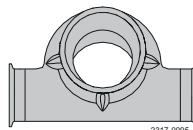

Figure 2. Clamp ends

#### State of the art – Cleanability

The Unique Mixproof HT valve also provides a state of the art solution when there is no CIP pressure or flow from the tank side to clean the seat and plug. The valve is self-cleaning, thanks to two patented Cleaning-in-Place (CIP) nozzles. The first nozzle is designed specifically for plug cleaning. This double-acting nozzle projects cleaning solution through the tank connection, ensuring complete cleaning of the seat contact surfaces as well as the shadow area of the tank port. The second is a rotating CIP nozzle incorporated into the unit for optimum cleaning of the full-bore leakage chamber.

The design of the single valve body makes it suitable to weld directly on the tank or to connect it via a Tri-clamp.

The 4" and 6" models feature a 45-mm opening, which enables the passage of very large particles or efficient handling of high viscosity fluids.

#### Options:

- Male parts or clamp liners in accordance with required standard.
- Control and Indication: ThinkTop or ThinkTop Basic.
- Side indication for detection of upper seat lift.
- Product wetted seals in HNBR, NBR or FPM.

### Pressure drop/capacity diagrams

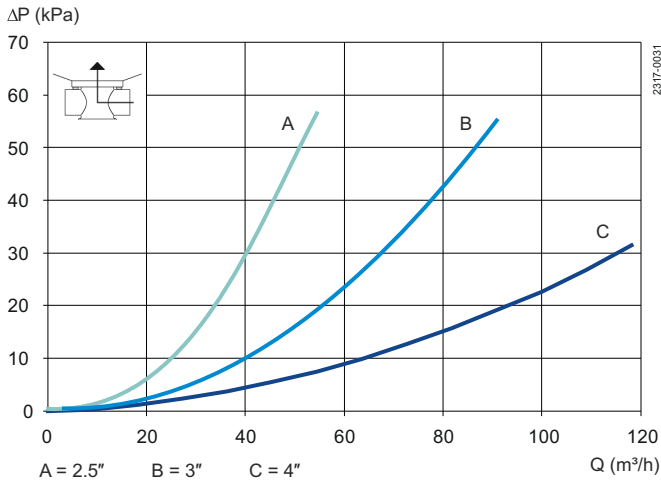

Figure 3. Unique Mixproof Horizontal Tank Valve - to tank

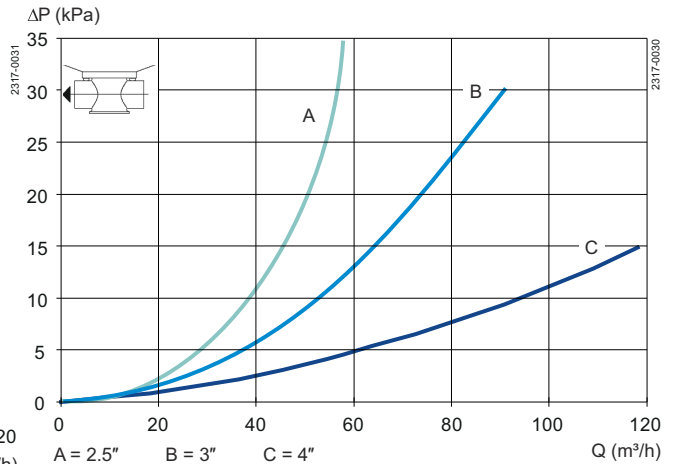

Figure 4. Unique Mixproof Horizontal Tank Valve - straight through

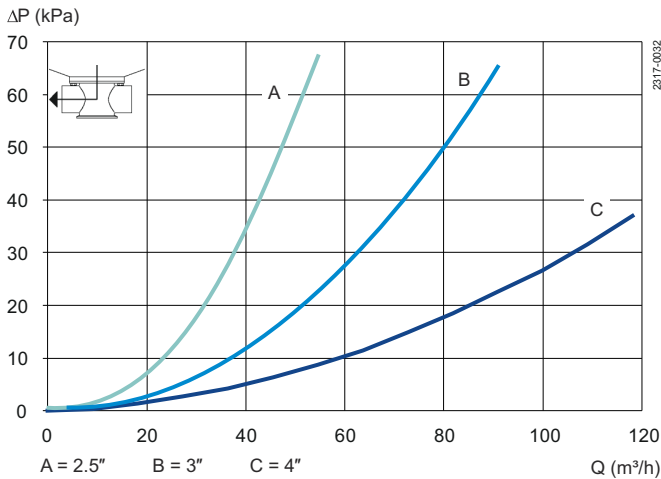

Figure 5. Unique Mixproof Horizontal Tank Valve - from tank

### Air and CIP consumption

Size	DN/OD		
ISO	2½"	3"	4"
<b>Kv-value</b>			
Upper Seat-lift [m³/h]	2.5	2.5	3.1
Lower Seat-lift (tank seat lift) [m³/h]	11.5	11.5	34.1
<b>Air consumption</b>			
Upper Seat-lift * [n litre]	0.4	0.4	0.62
Lower Seat-lift (tank seat lift) * [n litre]	0.13	0.13	0.21
Main Movement * [n litre]	1.62	1.62	3.54
<b>Kv-value - SpiralClean</b>			
External CIP in leakage chamber [m³/h]	1.52	1.52	1.52

\* [n litre] = volume at atmospheric pressure



#### Note!

Recommended min. pressure for External CIP in leakage chamber 3 bar.

#### Formula to estimate CIP flow during seat lift:

(for liquids with comparable viscosity and density to water):

$$Q = Kv \cdot \sqrt{\Delta p}$$

$$Q = \text{CIP - flow (m}^3\text{/h)}$$

Kv = Kv value from the above table

$\Delta p$  = CIP pressure (bar)

### Dimensions (mm)

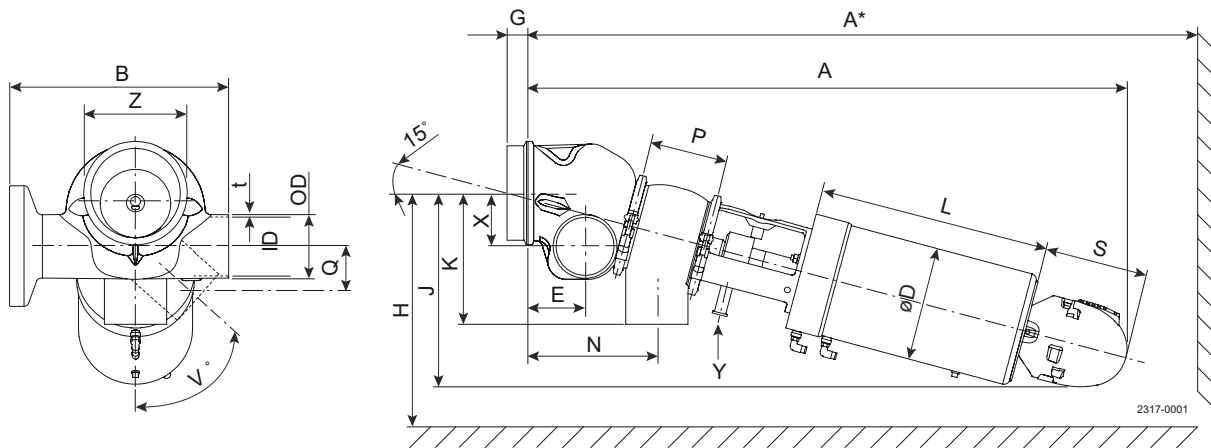

Size	2.5"	3"	4"
A	735	759	977
A*	867	904	1155
B (same for welding and clamp)	245	245	342
OD	63.5	76.1	101.6
ID	60.3	72.9	97.6
t	1.6	1.6	2
øD	186	186	186
E	70.9	77.2	92.2
F1	38	38	75
F2 (Tank plug)	10	10	10
G	15.9	15.9	38.1
H	281	291	364
J	246	252	317
K	153	158	215
L	252	252	379
N	152	170	210
P	89.3	101.9	126.6
Q	15.9	15.9	38.1
S	180	180	180
V°	0-67°	0-60°	0-53°
X	38,3	36,6	52,6
Y	3/4" clamp ferrule	3/4" clamp ferrule	3/4" clamp ferrule
Z	4"	4"	6"
Weight (kg)	13.0	14.2	43.1

This document and its contents are subject to copyrights and other intellectual property rights owned by Alfa Laval AB (publ) or any of its affiliates (jointly "Alfa Laval"). No part of this document may be copied, re-produced or transmitted in any form or by any means, or for any purpose, without Alfa Laval's prior express written permission. Information and services provided in this document are made as a benefit and service to the user, and no representations or warranties are made about the accuracy or suitability of this information and these services for any purpose. All rights are reserved.

### How to contact Alfa Laval

Up-to-date Alfa Laval contact details for all countries are always available on our website at [www.alfalaval.com](http://www.alfalaval.com)