

Alfa Laval LKRK

For easy tank cleaning duties

Intro

The Alfa Laval LKRK is a fixed static spray ball for hygienic and industrial applications. It is designed to clean tanks with capacities from 5-75 m³. The static spray ball, in general, uses a high flow rate and low pressure to clean the tank.

Application

The Alfa Laval LKRK is designed to remove simple residues from various tanks, such as Cleaning-in-Place tanks, milk silos, and water tanks, with a maximum diameter of ~Ø6 m. For sizing, contact Alfa Laval.

For tanks with tougher residues, Alfa Laval recommends using Rotary Spray Head, like the Alfa Laval SaniMidget, or Rotary Jet Head, like the Alfa Laval TJ20G which provides a hundred times more mechanical cleaning action.

Benefits

- Easy to inspect
- No moving parts
- Ideal for easy tank cleaning duties

Standard design

The Alfa Laval LKRK comes in two sizes: the LKRK-64 (Ø64) and the LKRK-94 (Ø94). Both spray balls are available with different spray patterns. The F-version provides 360° coverage, while the T and B versions provide a cleaning pattern that cleans only upwards or downwards. All spray balls are available with clip-on connections for both ISO and DIN tubes.

Working principle

The Alfa Laval LKRK shoots a small jet of fluid in: all directions (version F), upwards (version T) or downwards (version B). This allows the tanks to be cleaned by dousing the interior surfaces with small jets of hot water and/or chemicals which create a falling film of cleaning fluid that runs down the tank surface, generating cleaning action.

Spray balls are not ideal for use on tanks which require high cleaning action. For more difficult-to-clean applications, Alfa Laval recommends using a rotary spray head like the Alfa Laval SaniMidget or a rotary jet head like the Alfa Laval TJ20G.



Total cost of ownership

The rotary spray head, like the "Alfa Laval SaniMidget" and "Alfa Laval SaniMagum" will provide higher impact and lower the cleaning costs by 30%, while the rotary jet head, like the "Alfa Laval TJ20G" and "Alfa Laval TJ40G" will provide further savings. Up to 80% can be saved on the cleaning cost when using rotary jet head compared to the Alfa Laval LKRK.

Cleaning Pattern

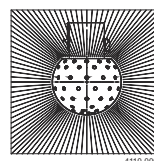

F-version

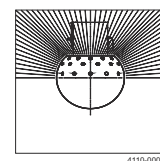

T-version

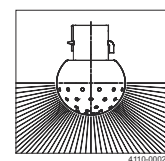

B-version

PHYSICAL DATA

Materials

| | |
|---------------------------------|-------------------|
| Housing and sprayhead assembly: | 316L (UNS S31603) |
| Finish: | Bright |

Connections LKRK

Type LKRK 64

| | |
|-----------|---------------------------|
| ISO tube: | 25 mm |
| DIN tube: | DN25 - pipe range 1 and 2 |

Type LKRK 94

| | |
|-----------|---------------------------|
| ISO tube: | 51 mm |
| DIN tube: | DN50 - pipe range 1 and 2 |

Dimensions (mm)

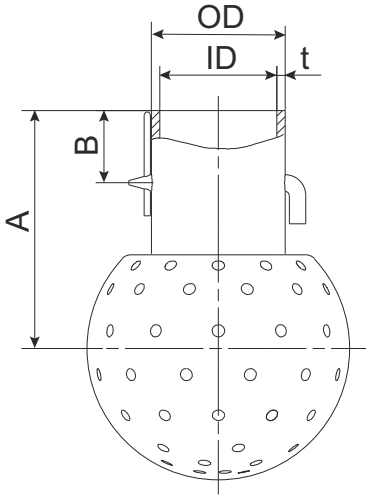

| Size | 64 | 94 |
|-------------------------------|----------------|---------------|
| A | 58 | 77.5 |
| B | 17.5 | 22.5 |
| US tube ID | 25.7 | 51.6 |
| ISO tube OD/ID/t | 28.5/25.5/1.5 | 54.4/51.4/1.5 |
| DIN tube OD/ID/t Pipe range 1 | 32.5/28.5/2 | 54.4/52.4/1 |
| DIN tube OD/ID/t Pipe range 2 | 34.2/29.5/2.35 | 57.4/53.4/2 |
| Weight, kg | 0.2 | 0.3 |

Flow rate demand

Horizontal tank

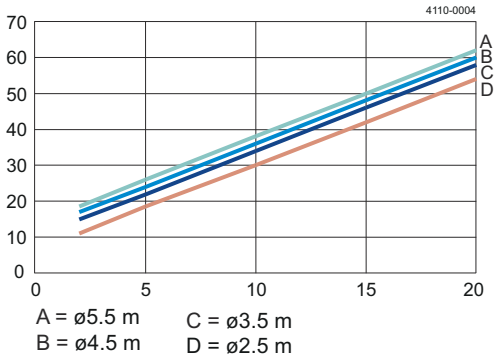

Vertical tank

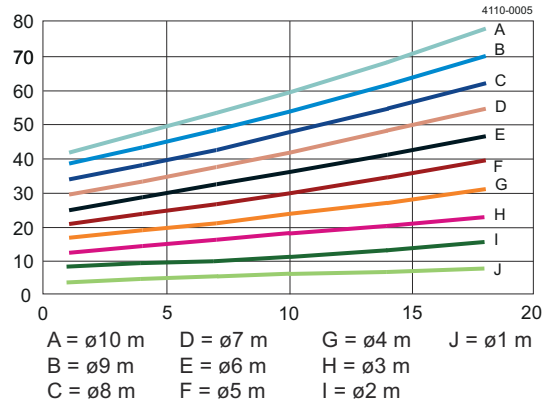

Capacity diagrams - LKRK

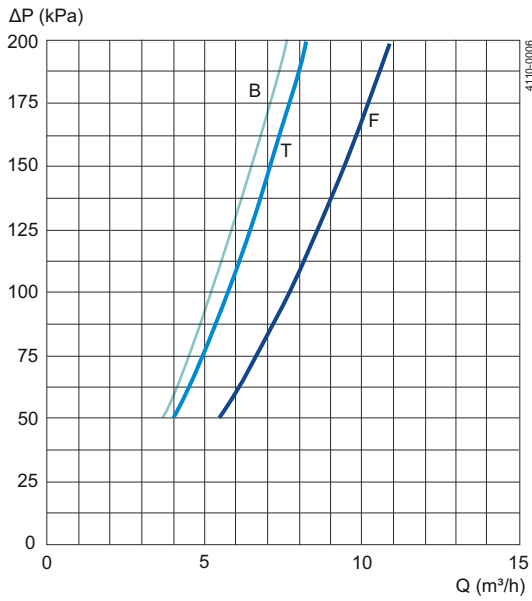

Type LKRK 64 with 2 mm holes:
 bottom drilled, top drilled, fully drilled
 B = Bottom drilled
 T = Top drilled
 F = Fully drilled

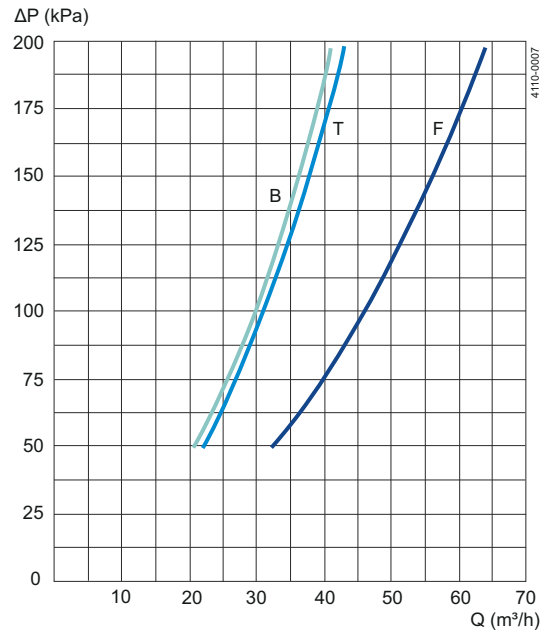

Type LKRK 94 with 3 mm holes, 51 mm (DN50) tube:
 bottom drilled, top drilled, fully drilled
 B = Bottom drilled
 T = Top drilled
 F = Fully drilled

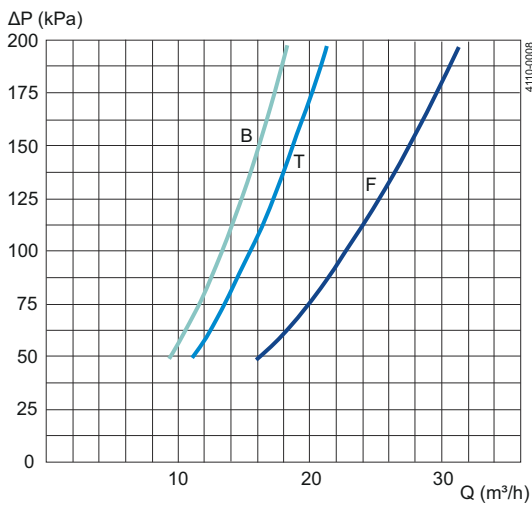

Type LKRK 94 with 2 mm holes, 51 mm (DN50) tube:
 bottom drilled, top drilled, fully drilled
 B = Bottom drilled
 T = Top drilled
 F = Fully drilled

This document and its contents are subject to copyrights and other intellectual property rights owned by Alfa Laval Corporate AB. No part of this document may be copied, re-produced or transmitted in any form or by any means, or for any purpose, without Alfa Laval Corporate AB's prior express written permission. Information and services provided in this document are made as a benefit and service to the user, and no representations or warranties are made about the accuracy or suitability of this information and these services for any purpose. All rights are reserved.

How to contact Alfa Laval

Up-to-date Alfa Laval contact details for all countries are always available on our website at www.alfalaval.com